

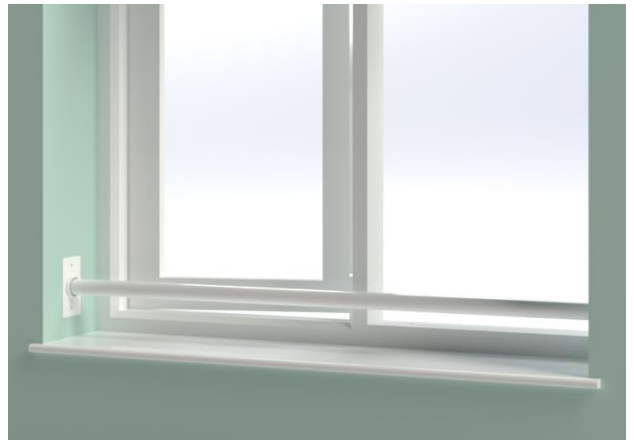

Bullfix Window Guard Data Sheet



The Bullfix Window Guard is designed for interior installation to window apertures, in order to assist developers in meeting Building Regulations Part O - 3.8 Protection of falling requirements.

FEATURES

Certified: The Bullfix Window Guard has been structurally tested to carry the required uniformly distributed loading and point loading by a UKAS approved testing facility, according to BS 6180:2011

Ease of installation: The Bullfix Window Guard can be fixed to the internal window reveals using two end brackets supplied in the system. Each bracket comes with suitable fixings for application to plasterboard with a cavity behind it, or plasterboard bonded directly to a wooden stud / masonry substrate. Fixing hole positions are designed to give sufficient clearance / access for use with power tools.

Flexibility: Available in three standard lengths which can then be adjusted on site to suit the specific openings created.

APPLICATION+

Bullfix Window Guards can be applied to standard gypsum plasterboard (12.5mm -16mm thick) with a cavity behind it, or any plasterboard bonded directly to a wooden stud / masonry substrate.

To be positioned along the horizontal plane so that a 100mm sphere cannot pass through any gaps above the bottom window reveal and below 1100mm (+0mm / -100mm) in height from the floor.

CONFIGURATION OPTIONS:

Window bar system comprising of:

BAR:

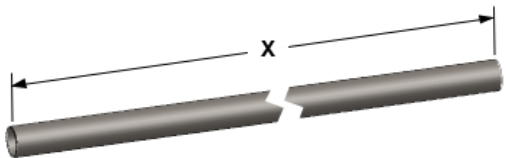

CODE	DIAMETER	LENGTH "X"
SB38 1000	38.2mm	1000mm
SB38 1250	38.2mm	1250mm
SB38 1800	38.2mm	1800mm



BRACKET:

CODE: BU BAR BRKT 001



CODE: BU TWIN BAR BRKT 001

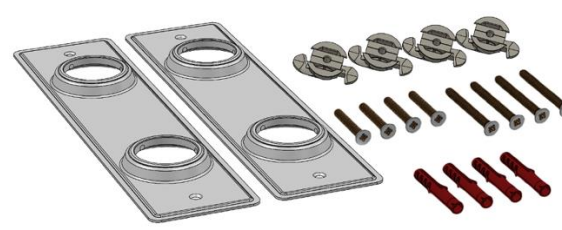

BRACKET WORKING RANGES

Prevention of falling tolerance
1100mm +0 / -100

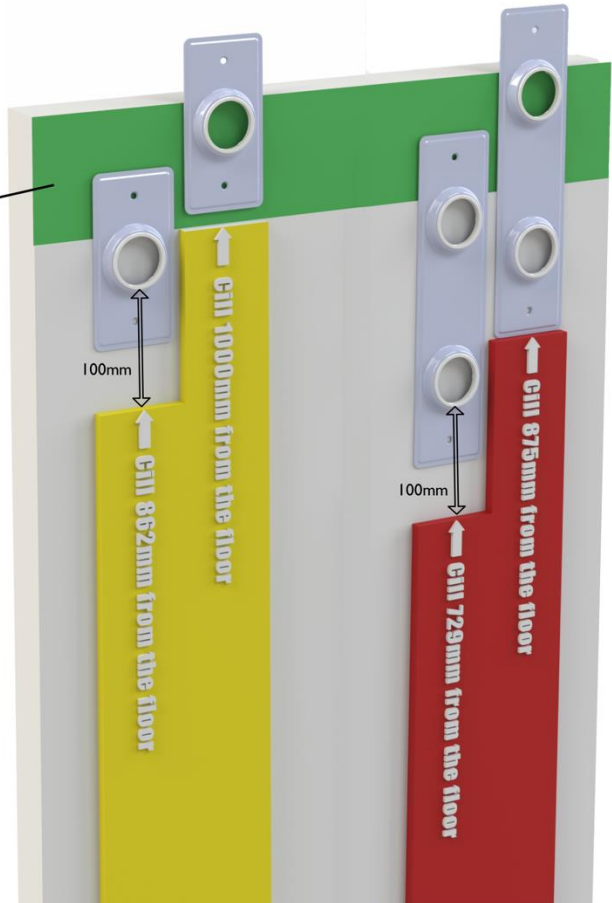

BRACKET DIMENSIONS

BU BAR BRKT 001

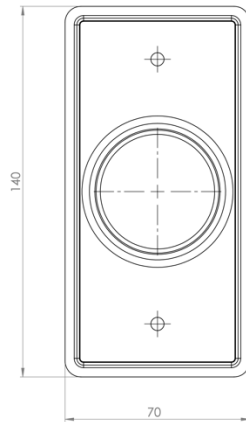

BU TWIN BAR BRKT 001

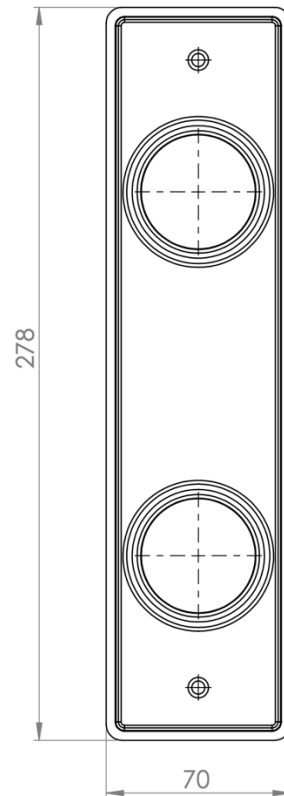

TESTED STANDARDS

Independently tested to BS 6180-2011 for domestic activities and most commercial applications (see test report for commercial application details)

Test Reports:

Lucideon UK241116

Lucideon UK241858

ADDITIONAL INFORMATION

Finish Options: White Powder Coat

Guarantee: 3 Years

* Installation to be strictly in accordance with manufacturer instructions *

UK Address:

Bullfix Ltd,
Wilmhurst Road, Warwick CV34 5LN

web: <https://bullfix-fixings.com>

email: info@bullfix.co.uk

EU Address:

Bullfix Ltd,
5 Fitzgerald Sq Dublin 2, EIRE

web: <https://bullfix-fixings.com>

email: info@bullfix.co.uk



ISO 9001 - Cert 186724
ISO 14001 - Cert 186725